

Part No. L05300

638 x 4 Single Section 'L' Range Bobbin

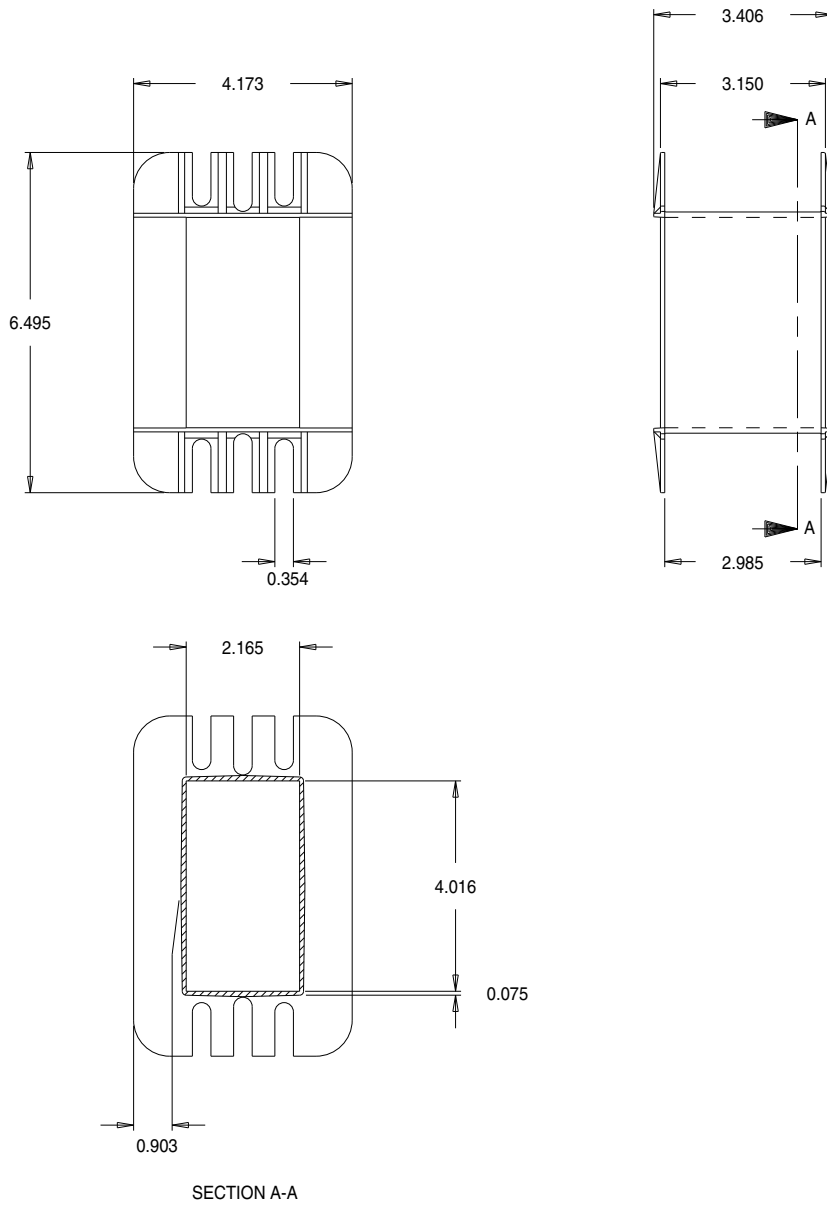

Dimensions in inches.



Issue 1